

**PRZEKROJE POPRZECZNE**  
**SKALA 1:20/100**

0+000 PT

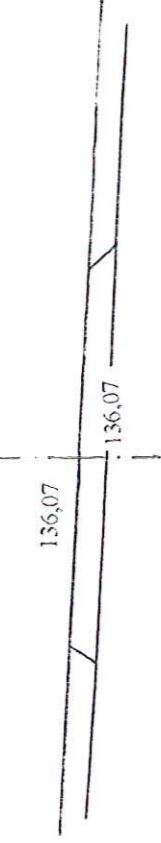

W = 4,04  
N = 0

0+020,00

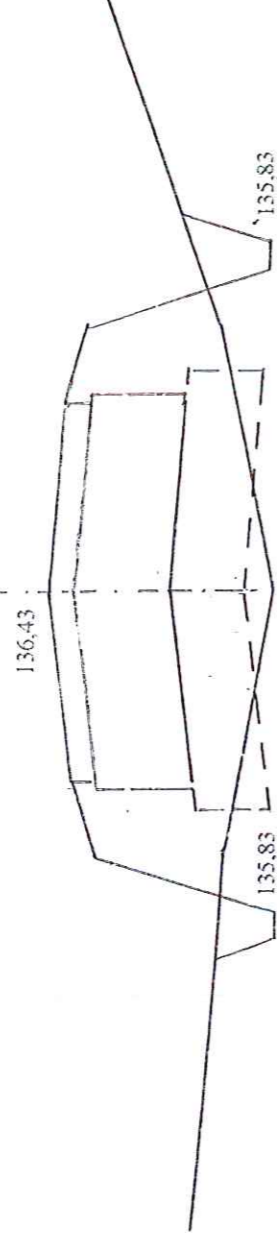

W = 0,32  
N = 1,02

0+042,00

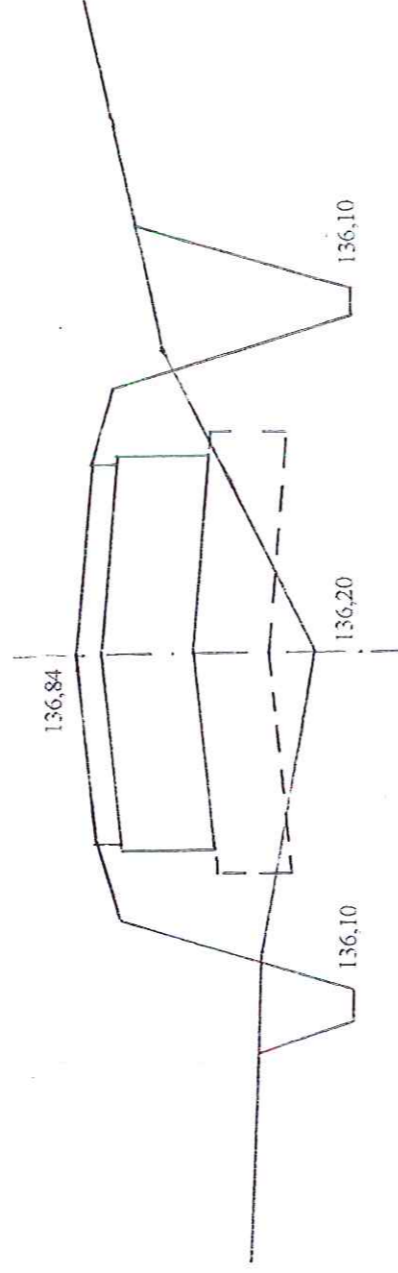

W = 0,94  
N = 0,82

0+062,00

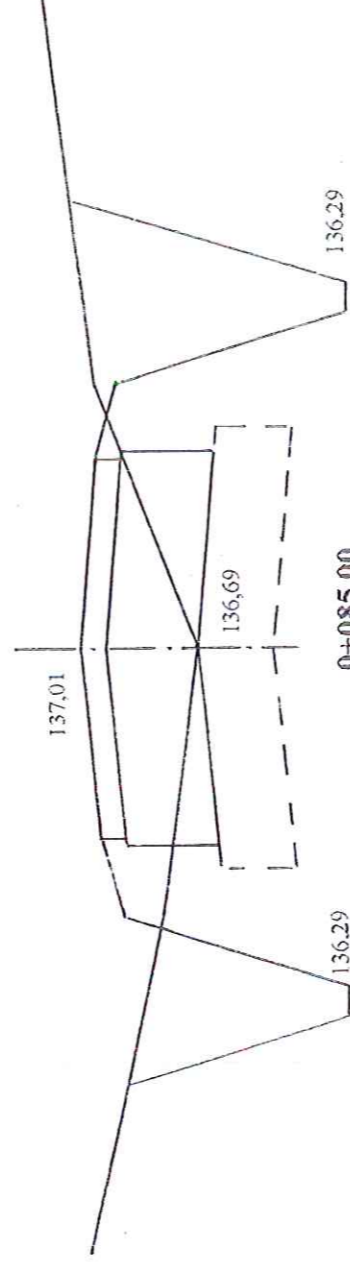

W = 3,48  
N = 0,18

0+085,00

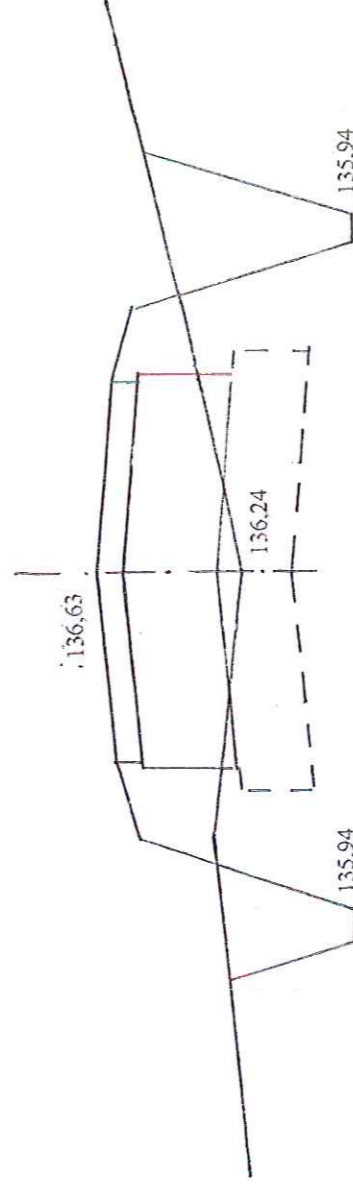

W = 2,02  
N = 0,42

0+105,00

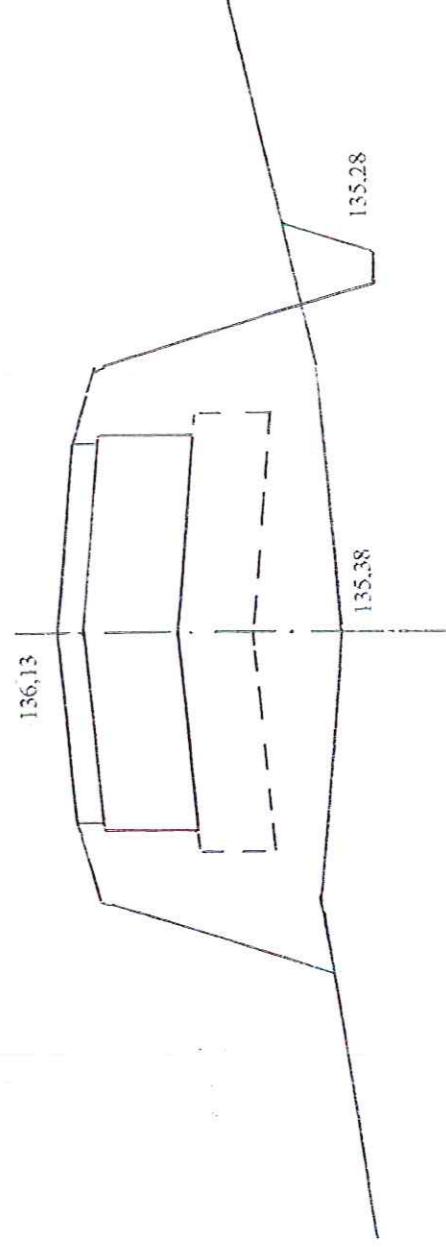

W = 0,10  
N = 1,42

0+125,00

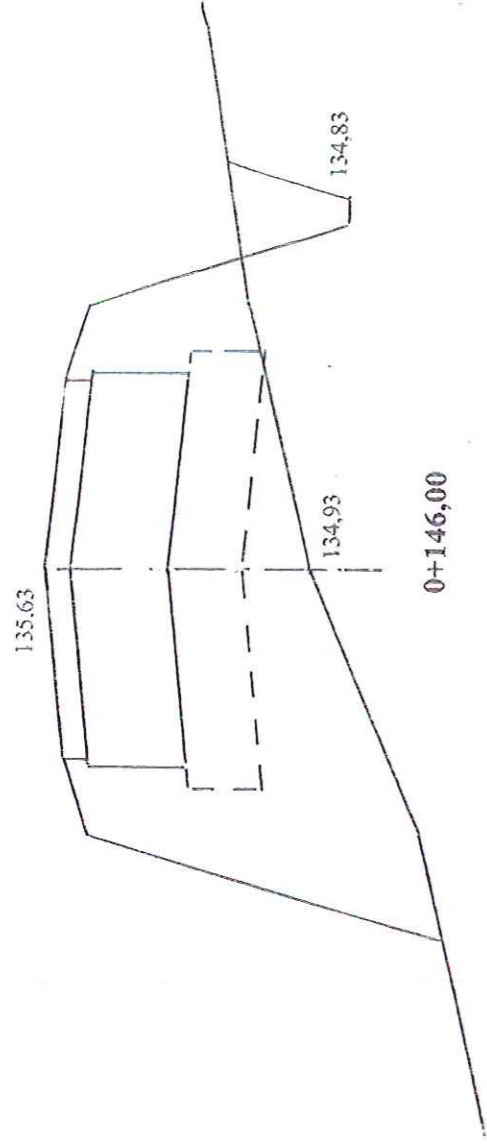

W = 0.12  
N = 2.10

0+146,00

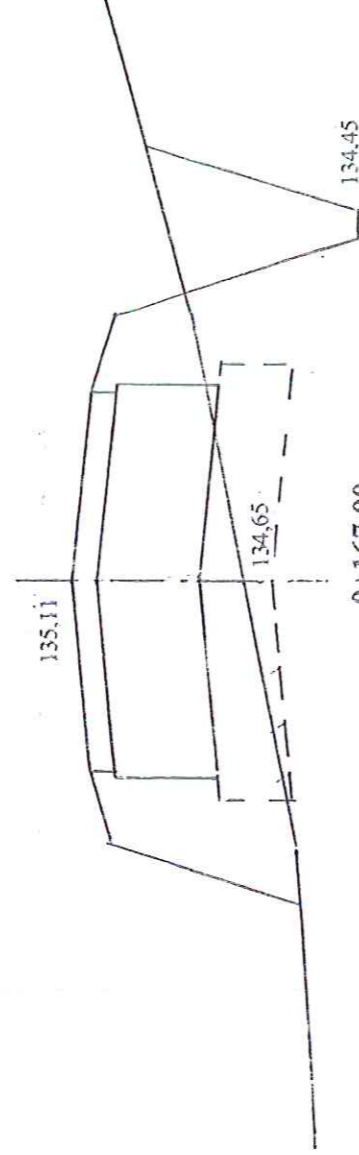

W = 1.00  
N = 0.92

0+167,00

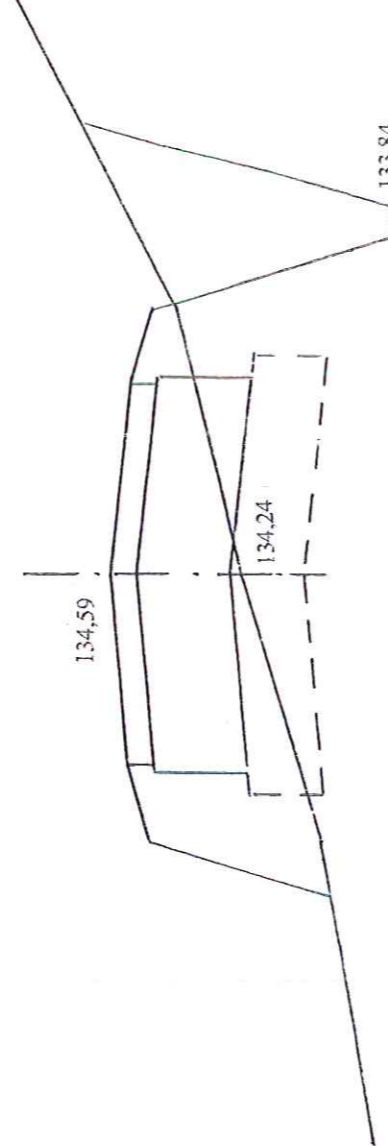

W = 1.94  
N = 0.70

0+190,00

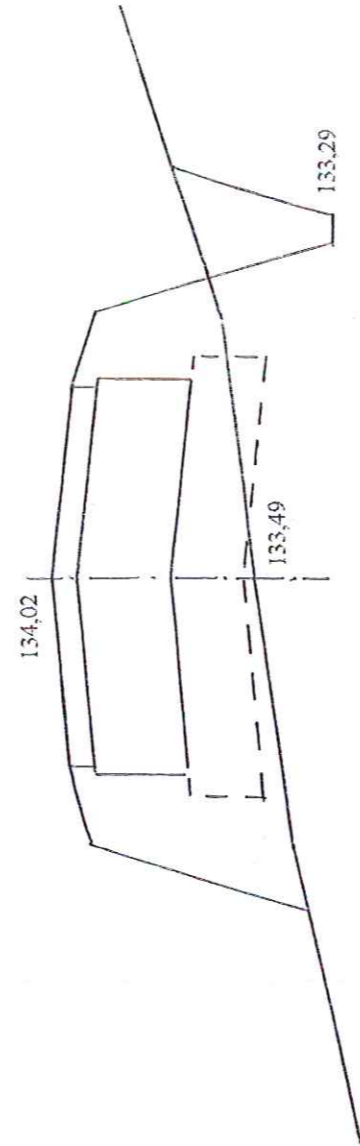

W = 0.42  
N = 1.00

0+200,00

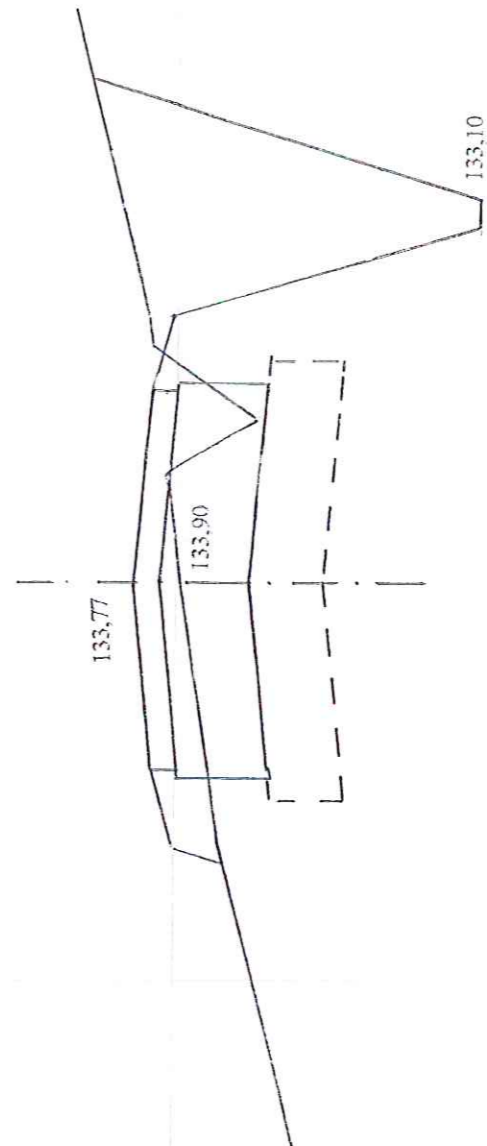

W = 3.62  
N = 0.21